

**ISIMET**

**LA Series**

**Utility Controller - Limited Application  
Single Source and Companion Styles**

**Ver 4.41 pcb**

**(Having 24-vac; and 12-vac or 12-vdc output circuit)**

**Utilizing LAIP Independent Control Panel(s)**

**Installation, Operations, Start-up and  
Maintenance Instructions**

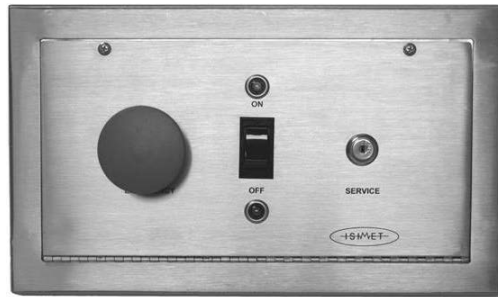

**Application:**

The LA Series Single Source and Companion Style Controllers operate as dual output controllers. This Unit is ideally suited for the instructor's desk within the classroom where a single switch can operate all connected utilities.

The Unit can be companioned to other Controllers to permit inter-action between units for Panic Response.

<b>Table of Contents:</b>	<u>Page</u>
Warranty.....	2
Enclosure Specifications and Dimensions.....	3
Styles.....	3
Model Number.....	3
Mounting Instructions (Surface Mount).....	4
Circuit Output Configurations.....	5
Monitoring Configurations.....	5
Installing the Electrical Conduit.....	6
Wiring the Unit.....	6
Wiring Configurations..	6
Operation of Unit.....	7
Equipment Maintenance.....	7

**ISIMET LA Series Utility Controller**

Installation, Maintenance, Operations, and Startup Instructions

Copyright © 2015 **ISIMET/MAPA, LLC**

*ISIMET* is a trademark of *ISIMET/MAPA, LLC*, an affiliate of **WCM Industries, Inc.**

All rights reserved.

Patent 6,757,589 B1, 6,990,393 B2

This document is copyrighted. This document may not, in whole or part, be copied, duplicated, reproduced, translated, electronically stored, or reduced to machine readable form without prior written consent from **ISIMET**.

Although the material contained herein has been carefully reviewed, **ISIMET** does not warrant it to be free of errors or omissions. **ISIMET** reserves the right to make corrections, updates, revisions, or changes to the information contained herein.

**Warranty:**

*ISIMET* will repair or replace any defective parts or workmanship of this product for a period of one year from date of installation. The Primary Operating P.C. Board has a two year limited warranty. Damage caused by incorrect installation or improper usage is not warranted. Failure to follow recommended installation, operation, and/or maintenance procedures listed in this manual may void product warranty. Recovery rights shall be limited to the total sum of the amounts paid for the product by the purchaser.

**Limits of Liability:**

*ISIMET's* liability shall be limited to costs of repair or replacement parts. The Laboratory Service Panel and Utility Controller are not intended for usage other than those expressly described in this manual. *ISIMET* shall not be liable for damage or injury caused by the improper use of the product.

*ISIMET* does not warrant against or assume liability for failure of operation or lack of notification to secondary integrated monitoring systems. The system should be thoroughly tested and adjustments made at time of initial operation. Periodic testing should be conducted by the user to assure that all components function and operate according to specifications.

Care should be taken in the installation of this product. *ISIMET* shall not be liable for damage or injury caused from the improper installation of the product.

Warranty is Subject to Compliance with Specific Installation Requirements.

**EXTENDED WARRANTY:**

*ISIMET* will extend the warranty period of the products when installation complies with all start up procedures and that a factory authorized agent either performs or is in attendance during start-up of the system(s). Controllers, Companion and Accessory Panels will be extended to a period of five years from date of installation. Except for *ISIMET* FLA, DLA, RLA and other Units where automation systems are not common, Control System(s) must be interfaced with a building automation system or other *ISIMET* approved time sequencing control for "non-use" system shutdown. All operating components of the system must be *ISIMET* provided. Prescribed routine maintenance procedures must be performed per *ISIMET* recommendations.

All Start-up and Routine Maintenance Documentation shall be per Factory Recommendation.

Further, required start-up and maintenance procedures must be performed as directed upon all affected systems. This warranty shall only become enforceable upon issuance of application specific Extended Warranty Document. A copy of this document should be maintained at all times at the location of the warranted systems.

**DISCLAIMER OF IMPLIED WARRANTY:**

**THERE ARE NO WARRANTIES THAT EXTEND BEYOND THE DESCRIPTION HEREIN. SELLER DISCLAIMS ANY IMPLIED WARRANTY OF MERCHANTABILITY OF THE GOODS OR OF THE FITNESS OF THE GOODS FOR ANY PURPOSE, AND BUYER AGREES THAT THE GOODS ARE SOLD "AS IS."**

**NOTE: Only qualified craftsmen licensed within the governing jurisdiction to perform the work associated with this installation should install and/or service this equipment.**

Printed in the United States

**Specifications:**

LAIP Panel - Stainless Steel 16 gauge  
9.875 X 16

Wall Box – 16 gauge powder coated sheet metal  
12.0 X 10.0 X 4.0

\* all dimensions are in inches

Output Reset Switch: (Where Provided)

Reset Switches are specifically rated to accommodate output load requirements.

Styles	# Output Circuits	Transformer	Panel Fuse	pcb Fuse 1	Output Rating (Standard)	Relay Rating
LA -2 & LA - 3	2 @ 120 vac	1 amp	20 amp	1 amp	15 amp @ 120 vac Max.	1 @ 15 amp @ 120 vac 1 @ 2 amp @ 120 vac
LA -2 & LA - 3	2 @ 24 vac	3 amp	5 amp	3 amp	2 @ 2 amp @ 24 vac 3 amp MAX	2 @ 2 amp @ 24 vac
LA -2 & LA - 3	1 @ 120 vac 1 @ 24 vac	3 amp	20 amp	3 amp	1 @ 15 amp @ 120 vac 1 @ 2 amp @ 24 vac	1 @ 15 amp @ 120 vac 1 @ 2 amp @ 24 vac

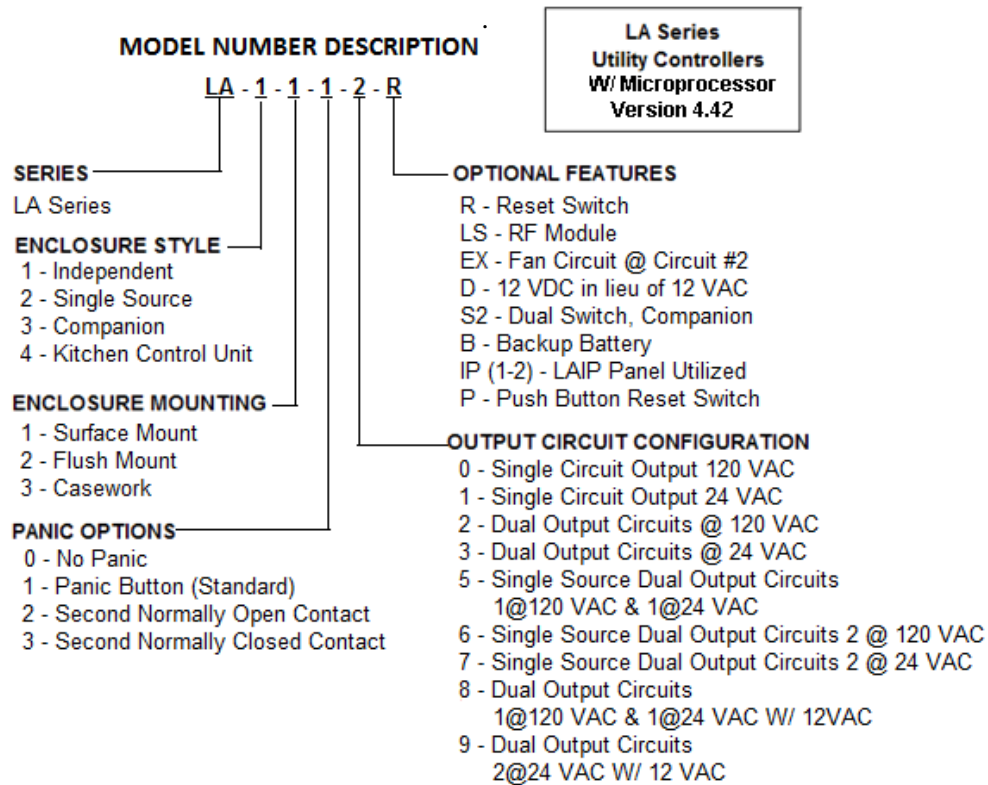

NOTE: Output Configurations 5, 6, 7, 8 and 9 are intended to operate with specific operators and solenoids for applications such as Instructor's Demonstration Stations and Science Preparation Rooms. When Configurations 2 or 3 are specified with Single Source Units, then Outputs are typically provided as single switch operators with or without a Reset per each output.

Units with IP(X) Suffix are mounted within a 12X10X4 Enclosure with a Keyed Lock Solid Door Panel. Units with IP(2) combine two (2) LA Units within one enclosure with a single power switch and transformer to operate both LA Units within. Where the suffix "D" appears in the model number along with IP(2) then the units are housed within a 16X14X6 Enclosure.

## Mounting Instructions: Surface Mount

In order to surface mount the unit, it is necessary to attach the provided brackets to the rear of the housing. Care should be taken to verify that the mounting means securely fastens the unit to the wall surface.

CAUTION: Provided mounting hardware must be used.

Output fuse on PCB, FUSE 1 is Slow Blow. PCB circuit fuse, FUSE 3 is 500 mA Fast Acting  
Inclusion of 12-vdc output does not change the ratings as shown in the table.  
Where 2 LA Controllers W/ IP (2) suffix are combined in one enclosure the Transformer may be 4 amps  
And Panel Fuse may be 20 amp

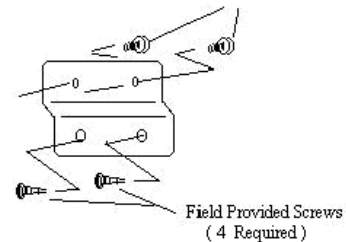
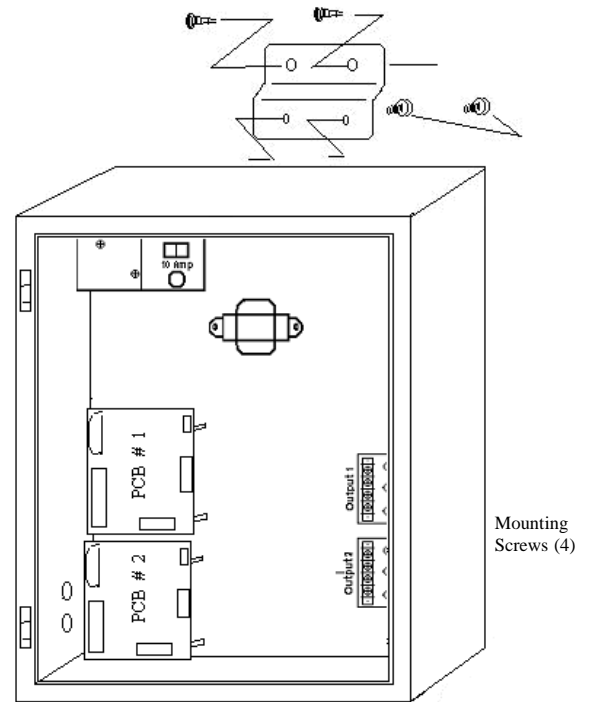

## Styles:

Single Source – Unit provides a single workstation with control over 120-vac convenience outlets as well as up to three 24 or 120-vac solenoid valves to operate domestic water and/or natural gas at the station. A single switch controls all output circuits.

Companion – The Single Source Unit is configured so as to serve as a companion output source for our Utility Controller where the application requires a single workstation such as an instructor's demo station to be controlled by a single remote output circuit.

- All Standard Styles are provided with Panic Button Assembly.

Transformer ratings are determined by actual application requirements.

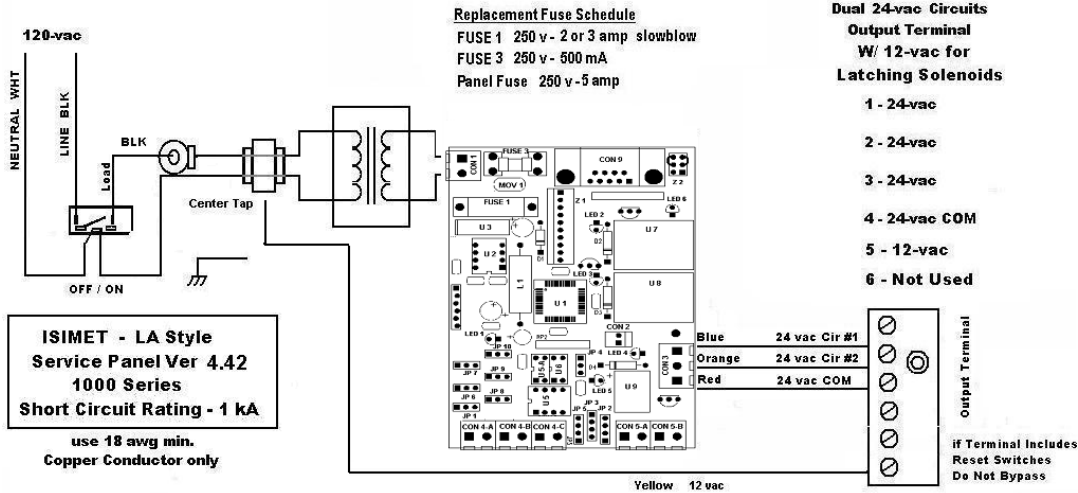

W/ 24-vac Output  
and  
W/ 12-vac Output

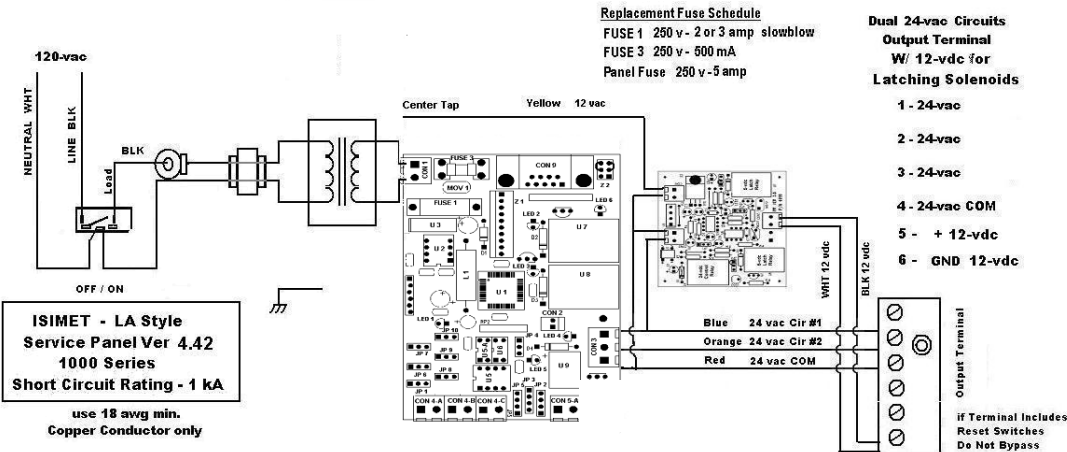

W/ 24-vac Output  
and  
W/ 12-vdc Output

### Output Circuits

Where Reset Switches are provided @ Output Terminal, DO NOT Bypass.

12-vac Output is intended for use W/ ISIMET Latching Solenoids located within an ISIMET S-Series Enclosure.

12-vdc Output is intended for use W/ free-standing ISIMET Latching Solenoids.

Care should be taken to insure that polarity is correct in order for 12-vdc solenoids to function as intended.

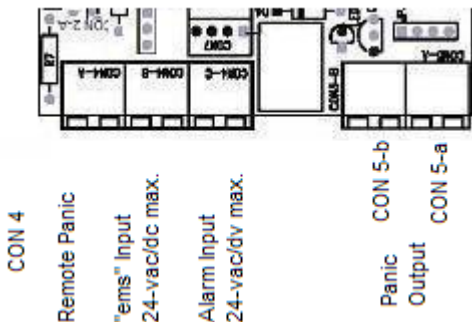

### Monitoring Circuit- JP3

Output Configuration Jumpers

@ Panic Output

1 jumper across center two posts  
= dry-contact @ CON 5-a.

2 jumpers across each pair of posts  
= 24-vac output @ CON 5-a.

CON 5-b is always dry-contact.

### WARNING!! Other pcb Jumper placements

Jumpers at JP 1, JP 4 and JP 5 are factory placed in order to configure the circuit board to specific functions for the Controller. Removal and/or re-placement may cause the unit to malfunction.

### **Installing the Electrical Conduit:**

Knockout holes for connecting the electrical conduits are located at the top left and right of the Wall Box.

- Connect rigid conduit for the required 120-vac electrical service.
- Connect conduit for the operating power to the upper left top of the enclosure at the junction box.
- Connect conduit for the operating power for the output to the upper right top of the enclosure.

### **Wiring the Unit:**

#### **Important!**

**Verify that the electrical supply is disconnected prior to connecting wiring to the Utility Controller.**

To wire the Controller:

1. Remove the junction box cover.
2. Make final connections to the 120-vac electrical service to wiring within the junction box. Verify that line wiring (Black), neutral (White), and ground wire (Green) are correctly connected.  
Minimum recommended wire size is 14 AWG.
3. Replace the junction box cover before activating or testing the unit.

### **Output Wiring Configurations:**

The Unit is factory configured as either 24-vac or 120-vac outputs. Two to Four output terminals are provided based on specifications for the Unit. The unit is equipped with a dedicated 120-vac rated at 15 amps for connection of a single convenience outlet circuit. See page 5 for typical wiring schematics. Do not attempt to modify the unit to accept other than voltage outputs as specified for the unit. To replace a PC Board not configured correctly for a specific application, contact the factory or a local representative.

### **Optional Input Control circuit:**

“EMS” Input: 24-vdc /vac active OFF will disable the operation of the unit.

Alarm Input: 24-vac/vdc active OFF. Refer to jumper configuration chart above. Make connection of this optional wiring at CON 4.

### **Optional Remote Panic Input Connection:**

An optional input from an ISIMET Remote Panic Assembly can be connected to the PCB at CON 4-a.

### **Optional Panic Output Terminal:**

A configurable Panic output is activated at CON 5. See configuration chart and location of this connector on page 5.

### **Connection of the Wall Panel Plug:**

The Unit is equipped with a 9 pin d-sub connector

- Insert plug onto circuit header on PCB and tighten.
- Turn Power **ON**.
- 

**CAUTION!** Do not install the panel until all wall finishes are complete. Verify that the plug is configured correctly. Incorrect insertion will prevent operation of unit.

### **Important!**

**All local codes must be followed when installing the unit and connecting the conduit to the service panel and making wiring connections. Do not install wiring or cable for integrated systems, remote panic assemblies or other interface wiring within conduit for either 24-vac control or 120-vac line voltage. Each wiring system including outputs should be housed in independent conduit and not bundled with wiring for other systems.**

**Failure to comply with these wiring specifics may create transient voltage at the pc board and cause system malfunction and/or failure.**

### **Operation of the Unit:**

**CAUTION:** Having outlets such as Gas Turrets Open when Services are activated can result in injury or death. Verify that these outlets are closed prior to activating the unit.

With the panel service switch(s) ON, engage the Key-switch. The circuit(s) will activate and the panel Green LED will illuminate to indicate that the services are active.

After turning the switch OFF, it will be necessary to re-engage the key switch in order to reactivate the service. The Red LED will illuminate when the services are OFF.

Pressing the panic button will deactivate the services. All Panel lights should illuminate with Panic.

Receipt of an Alarm Signal will deactivate the services. All Panel LEDs will illuminate and all output circuits will turn OFF.

Once in Panic or Alarm Modes the Key-switch must be engaged in order to reactivate service. The Alarm Signal must be withdrawn prior to reactivation.

Power to the solenoids should be turned OFF when utilities are not in service.

### **Equipment Maintenance:**

- ❑ The LA Series Controller should have semi-annual inspections.
- ❑ **ISIMET** recommends that you periodically conduct a brief test of the system to verify that the output circuit performs as intended.
- ❑ If examination of the unit indicates tampering, **ISIMET** recommends that you first review the installation and wiring portions of this manual prior to placing the unit in service.
- ❑ **ISIMET** recommends that when solenoids are operated by the unit, the piping systems be thoroughly flushed and cleaned and tested for leaks prior to placing the system into use. Periodic testing of these solenoids will assure that the piping system continues to function properly.

If you have any questions regarding the operation and maintenance of the Utility Controller, please contact an **ISIMET** Service Representative.

The enclosure has a NEMA 1 rating. It is not intended for use in wet areas. Exercise caution to prevent exposure of the interior compartment of the enclosure to moisture. If moisture is present within the enclosure, **ISIMET** recommends that the control switch be turned OFF, power be disconnected from the unit until the source of the moisture is determined, and all moisture is removed from the compartment.

The electronic controller (PCB) is sensitive to dust and other air-borne particles. Do not expose the interior compartment of the enclosure to dust. During the semi-annual inspection, if dust or other material is present, **ISIMET** recommends that you remove all foreign matter before operating the unit.

If the Unit fails to operate, **ISIMET** recommends that you check the power supply to the unit. With the control switch in the ON position, LED Fuse 1 should illuminate. If not, check the service breaker.

If the fuse is not damaged and the unit still does not function, contact **ISIMET** or your local Service Representative.

**CAUTION:**

**ISIMET DOES NOT** recommend that service to emergency and/or safety devices, such as emergency showers and eyewashes, be controlled by the Utility Controller System or Solenoids. Such devices are intended to operate independent of restrictive authority operation, as is the case with the design of this unit. **ISIMET** makes available components for the monitoring of such safety devices. Please contact **ISIMET** regarding any questions regarding this type of application.

***ISIMET* believes that sole and local authority means that the primary operator or the instructors should have the sole authority to start and stop the utility services within the immediate area of use during normal usage. This should distinguish this type of operating environment from that where a single emergency shut-down device is located remotely from the areas of use. As an example, the *ISIMET* system is not specifically intended for use in applications where a master shut-down and re-instate device is located away from areas of normal use. *ISIMET's* opinion is that in such cases there is risk that the operator of the system during re-start may inadvertently activate utilities in an unoccupied area that is remote from the present occupancy, thus creating the risk of injury and/or fire where the utility is fuel gas.**



**ISIMET/MAPA, LLC  
PO Box 129 (Mailing)  
103 W. CJ Wise Pkwy  
Naples, Texas 75568-0129**

**Phone (866) 897-0737  
Fax (903) 897-0740**

**[www.ISIMET.com](http://www.ISIMET.com)**

**Innovative Systems  
Integrating  
Mechanical and Electrical  
Technology**